

Maya2000 and Maya2000Pro Data Sheet

Description

The Ocean Optics Maya2000 Series Spectrometers (Maya2000 and Maya2000Pro) includes the linear CCD-array optical bench, plus all the circuits necessary for spectrometer operation. The result is a compact, flexible system, with no moving parts, that's easily integrated as an OEM component.



The Maya spectrometers are a unique combination of technologies providing users with high sensitivity for low light-level, UV-sensitive and other scientific applications. The electronics have been designed for considerable flexibility in connecting to various modules as well as external interfaces. The Maya interfaces to PCs, PLCs and other embedded controllers through a USB 2.0 connection. The information included in this data sheet provides detailed instructions on the connection and operation of both of the Maya spectrometers.

The detector used in the Maya spectrometer is a scientific-grade, back-thinned, CCD array from Hamamatsu (product number S9840 for Maya2000 and S10420 for Maya2000Pro). For complete details on these detectors, visit www.Hamamatsu.com.

The Maya operates from power provided through the USB, or from a separate + 5VDC power supply. The Maya is a microcontroller-controlled spectrometer, thus all operating parameters are implemented through software interfacing to the unit.

Features

- Hamamatsu high UV-sensitivity detector
 - S9840 Detector for Maya2000 with Peak QE: >90%
 - S10420 Detector for Maya2000Pro with Peak QE: 75%
 - Back-thinned for good UV sensitivity
 - MPP operation for low noise operation, low dark current, wide dynamic range
- Spectrometer Design:
 - Symmetrical Crossed Czerny Turner
 - 101.6 mm focal length
 - 15 gratings including the HC-1 composite grating
 - 6 slit widths
- Electrical Performance:
 - 16 bit, 500kHz A/D Converter
 - Integration time: 6ms – 10s (Maya2000)
6ms – 5s (Maya2000Pro)
- Embedded microcontroller allows programmatic control of all operating parameters and standalone operation:
 - USB 2.0 480Mbps (high-speed) and 12Mbps (full speed)
 - Communication Standards for digital accessories (I2C)
- Onboard Pulse Generator:
 - 2 programmable strobe signals for triggering other devices
 - Software control of nearly all pulse parameters
- Onboard GPIO:
 - 10 user-programmable digital I/O
- EEPROM storage for:
 - Wavelength Calibration Coefficients
 - Linearity Correction Coefficients
 - Absolute Irradiance Calibration (optional)
- Software and Quasi Real-time triggering
- Plug-n-Play Interface for PC applications
- 30-pin connector for interfacing to external products

Specifications

Specifications	Criteria
Physical Specifications: Physical Dimensions (LxWxH) Spectrometer Weight Power Supply Weight	149 mm (5.86 in.) x 109.3 mm (4.30 in.) x 50.4 mm (1.98 in.) 0.96 kg (2.1 lbs.) 0.45 kg (1 lb.)
Power: Power requirement Supply voltage Power-up time	500 mA at +5 VDC 4.5 – 5.5 V ~2s depending on code size
Absolute Maximum Ratings: V _{CC} Voltage on any pin	+ 5.5 VDC V _{CC}
Spectrometer: Design Focal length (input) Input Fiber Connector Gratings Entrance Slit Detector Pixels (active) Pixel size Spectral range Quantum efficiency Well Depth Sensitivity Dark Current Filters	Symmetric crossed Czerny-Turner F/4 101.6 mm SMA 905 to single-strand optical fiber (0.22 NA) 14 different gratings 5, 10, 25, 50, 100, or 200 μm slits. (Slits are optional. In the absence of a slit, the fiber acts as the entrance slit.) Maya2000: Hamamatsu S9840; Maya2000Pro: S10420 Maya2000: 2048 x 14; Maya2000Pro: 2048 x 64 14μm ² 165 – 1100nm Maya2000: >90% peak Maya2000Pro: 75% peak Maya2000: 130 Ke- Maya2000Pro: 200 Ke- Maya2000: ~0.45 counts/e-; Maya2000Pro: ~0.32 counts/e- 4000 e/pixel/sec (typ) @ 25° C; 200 e/pixel/sec (typ) @ 0° C OFLV-MAYA-200 an OFLV-MAYAPRO-200 available with HC-1 grating
Spectroscopic: Integration Time Dynamic Range (Typical) Dynamic Range (Guaranteed) Signal-to-Noise Dark Noise (single dark spectrum) Nonlinearity (uncorrected) Linearity (corrected)	Maya2000: 6 ms – 10s Maya2000Pro: 6ms – 5s Maya2000: 8000:1+; Maya2000Pro: 12000:1+ Maya2000: 5000:1; Maya2000Pro: 8000:1 Maya2000: 350:1; Maya2000Pro: 450:1 Maya2000: 13 RMS counts; Maya2000Pro: 8.2 RMS counts (Guaranteed) Maya2000: ~4%; Maya2000Pro: ~10% >99.7%

Maya Data Sheet

Specifications	Criteria
Environmental Conditions: Temperature Humidity	-30° to +70° C Storage & -0° to +50° C Operation 0% – 90% noncondensing
Interfaces: USB	USB 2.0, 480 Mbps

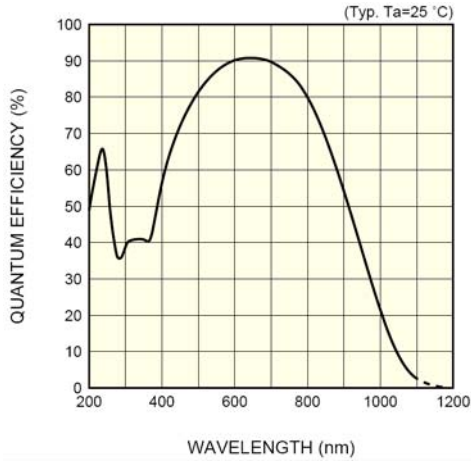

Quantum Efficiency of Maya2000 S9840 Detector S10420 Detector

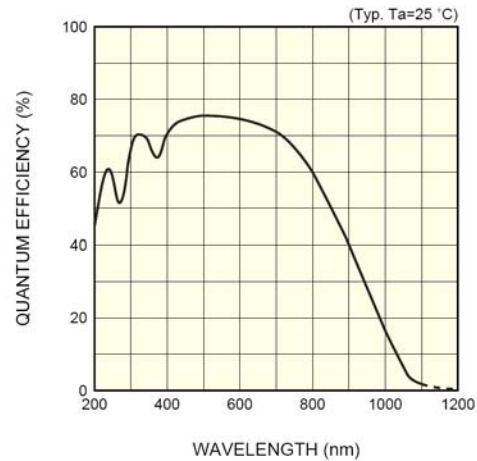

Quantum Efficiency of Maya2000Pro S10420 Detector

Optical Performance

The following table shows the Maya resolution for various slit sizes.

5 micron Slit	10 micron Slit	25 micron Slit	50 micron Slit	100 micron Slit	100 micron Slit
~1.5 pixels	~2.0 pixels	~2.5 pixels	~4.2 pixels	~8.0 pixels	~15.3 pixels

Mechanical Diagrams

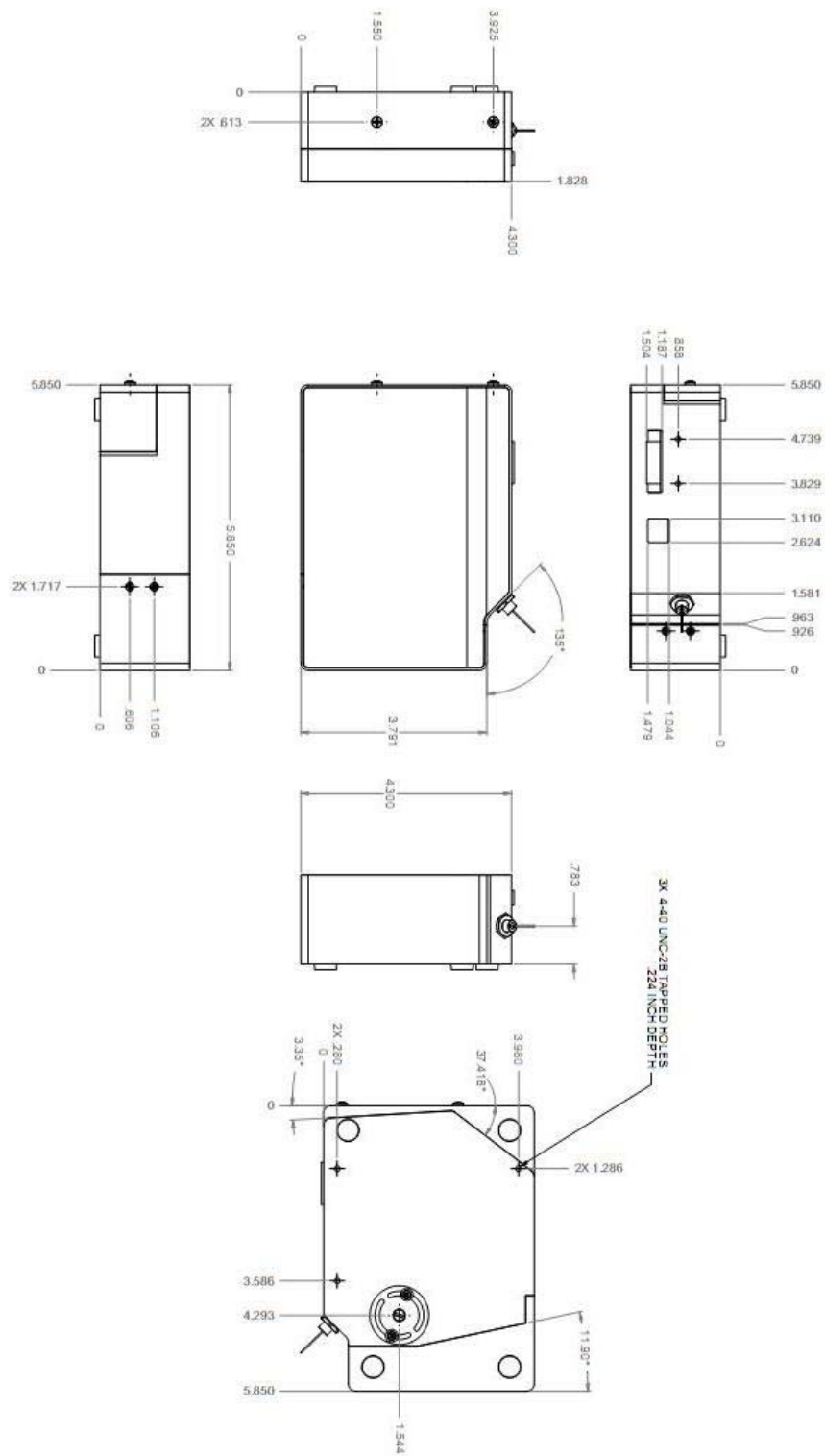

Electrical Pinout

Listed below is the pin description for the Maya Accessory Connector (J3) located on the front vertical wall of the unit. The connector is a Pak50TM model from 3M Corp. Headed Connector Part# P50-030P1-RR1-TG. Mates with part# P50-030S-TGF (requires two: 1.27mm (50 mil) flat ribbon cable: Recommended 3M 3365 Series)

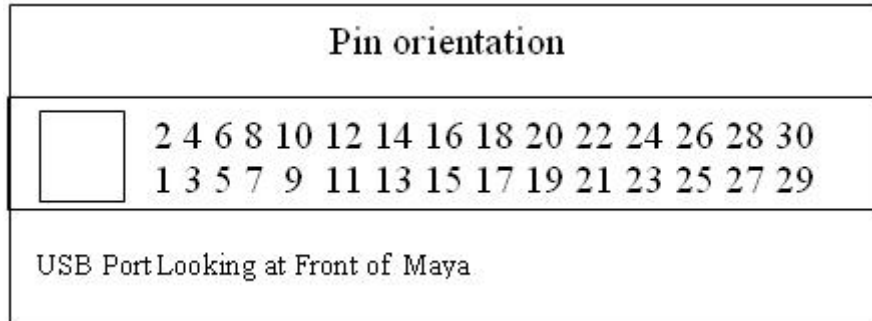

Pin #	Function	Input/Output	Description
1	N/A	N/A	Reserved
2	N/A	N/A	Reserved
3	GPIO (2)	Input/Output	Reserved
4	N/A	N/A	Reserved
5	Ground	Input/Output	Ground
6	I2C SCL	Input/Output	I2C clock signal for communication to other I2C peripherals
7	GPIO (0)	Input/Output	Base clock
8	I2C SDA	Input/Output	I2C data signal for communication to other I2C peripherals
9	N/A	Input/Output	Reserved
10	Ext. Trigger In	Input	TTL input trigger signal
11	GPIO (3)	Input/Output	Integration clock
12	VCC or 5VIN	Input or Output	Input power pin for Maya – When operating via USB, this pin can power other peripherals – Ensure that peripherals comply with USB specifications
13	N/A	Output	Reserved
14	VCC or 5VIN	Input or Output	Input power pin for Maya – When operating via USB, this pin can power other peripherals – Ensure that peripherals comply with USB specifications
15	SPI Data In	Input	SPI Master In Slave Out (MISO) signal for communication to other SPI peripherals
16	GPIO (4)	Input/Output	Reserved

Pin #	Function	Input/Output	Description
17	Single Strobe	Output	TTL output pulse used as a strobe signal – Has a programmable delay relative to the beginning of the spectrometer integration period
18	GPIO (5)	Input/Output	Acquire spectra (read enable)
19	N/A	Output	Reserved
20	Continuous Strobe	Output	TTL output signal used to pulse a strobe – Divided down from the master clock signal
21	N/A	Output	Reserved
22	GPIO (6)	Input/Output	Reserved
23	N/A	N/A	Reserved
24	N/A	N/A	Reserved
25	Lamp Enable	Output	TTL signal driven Active HIGH when the Lamp Enable command is sent to the spectrometer
26	GPIO (7)	Input/Output	Reserved
27	Ground	Input/Output	Ground
28	GPIO (8)	Input/Output	A/D trigger
29	Ground	Input/Output	Ground
30	GPIO (9)	Input/Output	EPFLAG

Maya2000 Spectrometer Detector

The Maya2000 contains a Hamamatsu S9840 CCD which is a two dimensional CCD. The Maya electronics only support reading out the device as a 1-D array (e.g. all rows are summed together on chip). The structure of the S9840 CCD is shown below. The device has 2048 x 14 active pixels and a total of 2080 x 20 pixels.

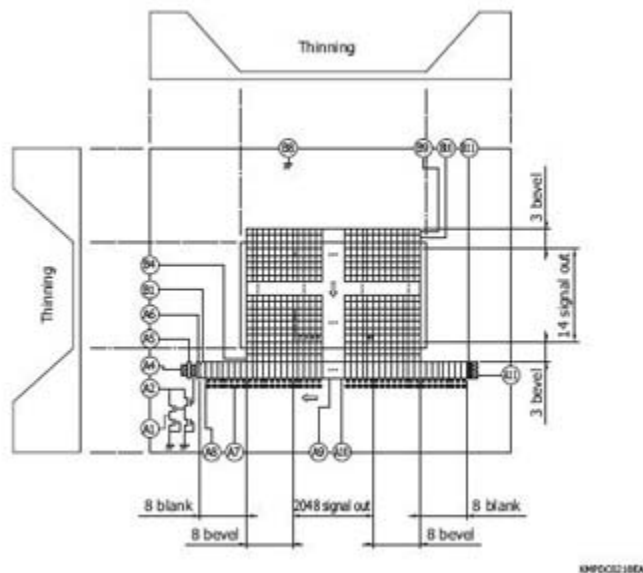

Maya2000 CCD Device structure. The device has 14 active vertical pixels and 2048 active horizontal pixels.

Maya2000Pro Spectrometer Detector

The Maya2000Pro contains a Hamamatsu S10420 CCD which is a two dimensional CCD. The Maya electronics only support reading out the device as a 1-D array (e.g. all rows are summed together on chip). The structure of the S10420 CCD is shown below. The device has 2048 x 64 active pixels and a total of 2068 x 70 pixels.

Pixel Definition

The following is a description of all of the pixels:

Maya 2000 Pixels

Pixel	Description
0–7	Optical Black pixels
8–15	Unusable
16–2063	Optical active pixels
2064–2071	Unusable
2072–2079	Optical Black pixels

Maya2000-Pro Pixels

Pixel	Description
0	Unusable
1–3	Dark
4–9	Bevels/unusable
10–2047	Spectrum (total of 2038)
2064–2067	Dark
2064–2067	Optical Black pixels

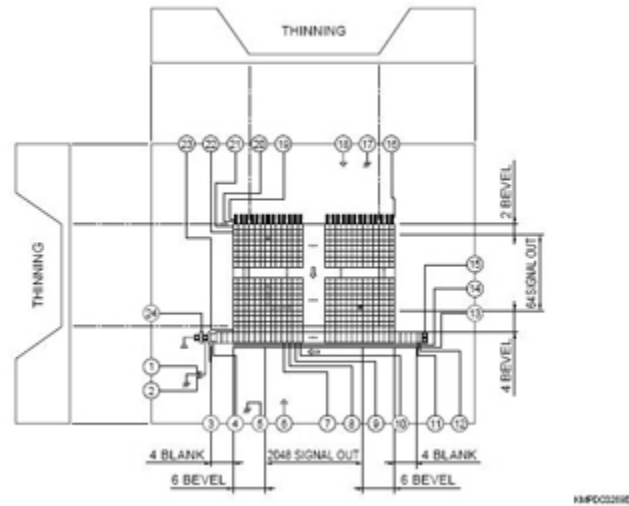

Maya2000Pro CCD Device structure. The device has 64 active vertical pixels and 2048 active horizontal pixels.

Timing Signals

Strobe Signals

Single Strobe

The Single Strobe (SS) signal is a programmable TTL pulse that occurs at a user-determined time during each integration period. This pulse has a user-defined delay and pulse width. The pulse is only active if the Lamp Enable command is active. This pulse allows for synchronization of external devices to the spectrometers integration period. The Strobe delay can range from 0 to 30 ms. In External Hardware Trigger mode, the timing of the Single Strobe is based on the External Trigger signal. In Normal (free running) and External Synchronization Trigger modes, the timing of the Single Strobe is based on the beginning of the integration period (the falling edge of SH that occurs during ICG). The timing diagram for the Single Strobe in External Hardware Trigger mode is shown below:

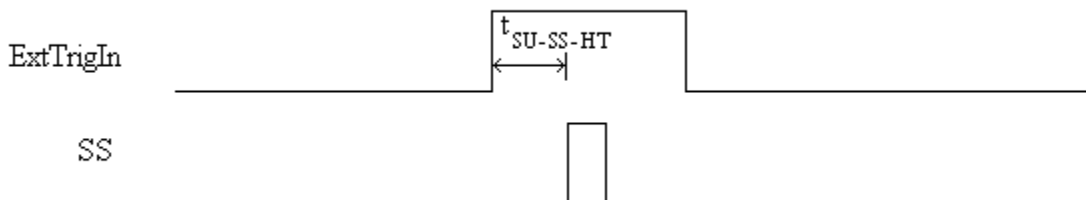

Single Strobe (External Hardware Trigger Mode)

The width and delay of the Single Strobe can be adjusted in 500ns increments. If the delay is set to 0, there is still a setup time between when ExtTrigIn goes HIGH, and when SS goes HIGH. This setup time is defined as $0 < t_{SU_SS_HT} < 0.6\mu s$. If the delay is set to something larger than 0 (which can be controlled by the user through the software interface), then the actual delay is the set delay plus $0 - 0.6\mu s$. So, for example, if the delay is set to $50\mu s$, the SS will begin between $50\mu s$ and $50.6\mu s$ after ExtTrigIn goes high.

The timing diagram for the Single Strobe in Normal or External Synchronization Trigger mode is shown below:

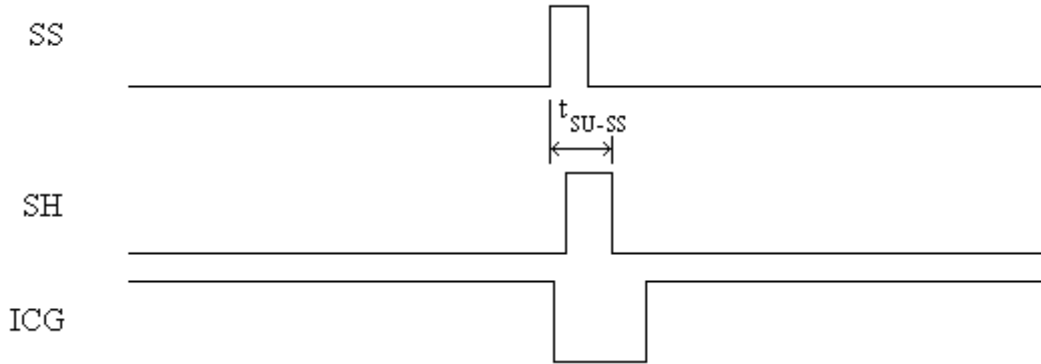

Single Strobe (Normal or External Synchronization Trigger Mode)

Similar to the Single Strobe signal in External Hardware Trigger mode, the width and delay of the Single Strobe in Normal or External Synchronization mode can be adjusted in 500ns increments. If the delay is set to 0, there is still a setup time between when SH goes LOW, and when SS goes HIGH. This setup time is negative, and is defined as $(-7.5\mu s < t_{SU_SS} < -9.5\mu s)$. If the delay is set to something larger than 0, then the actual delay is the set delay minus t_{SU_SS} . So, for example, if the delay is set to $50\mu s$, the SS will begin between $40.5\mu s$ and $42.5\mu s$ after SH goes LOW.

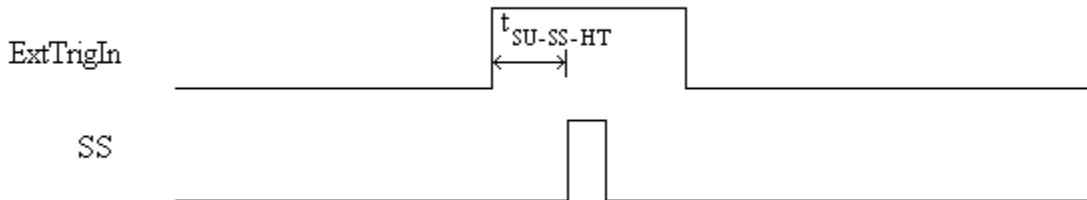

Continuous Strobe

The Continuous Strobe signal is a 976Hz pulse-train (50% duty cycle). The pulse is only active if the Lamp Enable command is active.

Synchronizing Strobe Events

If the application requires more than one pulse per integration period, the user needs to insure the continuous strobe and integration period are synchronized. The integration time must be set so that an equal number of strobe events occurs during any given integration period. This synchronization only occurs when the integration period is a multiple of a power of 2.

Maya Trigger/Acquisition Modes

The Maya supports 3 Trigger/Acquisition modes including the standard free running mode. Unfortunately the CCD does not have any means to instantly reset all of the pixels in microseconds, so the typical external hardware and external synchronization modes are not supported. The various modes are described below.

- **Free Running Acquisition Mode:** In this mode, the CCD is constantly being driven at the user specified integration time. When a spectra is requested via software, the Maya electronics wait for the current integration period to expire. Then at the start of the next integration period, they readout the CCD which contains the data for photons which were collected by the CCD in the previous integration period.
- **Software Trigger Mode:** This mode is basically the same as the Free Running Mode, except that the on-board microcontroller waits for the External Trigger line to be HIGH before starting the acquisition process.
- **Quasi-Real Time Acquisition Mode:** In this mode, the CCD is running at the integration period of 6ms. When spectra are requested, it waits for the current period to expire before sampling at the desired integration time. When that period completes it switches back to 6ms and reads out the CCD. The resulting lag between the trigger event and the image capture is a maximum 6ms delay.

Maya USB Port Interface Communications and Control Information

The Maya is a microcontroller-based Miniature Fiber Optic Spectrometer that can communicate via the Universal Serial Bus. This section contains the necessary command information for controlling the Maya via the USB interface. This information is only pertinent to users who wish to not utilize Ocean Optics 32 bit driver to interface to the Maya. Only experienced USB programmers should attempt to interface to the Maya via these methods.

Hardware Description

The Maya utilizes a Cypress CY7C68013A microcontroller that has a high speed 8051 combined with an USB2.0 ASIC. Program code and data coefficients are stored in external E²PROM that are loaded at boot-up via the I²C bus. The microcontroller has 8K of internal RAM and 64K of external SRAM. Maximum throughput for spectral data is achieved when data flows directly from the external FIFO's directly across the USB bus. In this mode the 8051 does not have access to the data and thus no manipulation of the data is possible.

USB Info

Ocean Optics Vendor ID number is 0x2457 and the Product ID is 0x102A.

Instruction Set

Command Syntax

The list of the commands is shown in the following table followed by a detailed description of each command. The length of the data depends on the command. All commands are sent to the Maya through End Point 1 Out (EP1). All spectra data is acquired through End Point 2 In and all other queries are retrieved through End Point 1 In (EP1). The endpoints enabled and their order is:

Pipe #	Description	Type	Hi Speed Size (Bytes)	Full Speed Size (Bytes)	Endpoint Address
0	End Point 1 Out	Bulk	64	64	0x01
1	End Point 2 In	Bulk	512	64	0x82
2	End Point 6 In	Unused	Unused	Unused	Unused
3	End Point 1 In	Bulk	64	64	0x81

USB Command Summary

EP2 Command Byte Value	Description	Version
0x01	Initialize Maya	1.01.0
0x02	Set Integration Time	1.01.0
0x03	Set Strobe Enable Status	1.01.0
0x05	Query Information	1.01.0
0x06	Write Information	1.01.0
0x09	Request Spectra	1.01.0
0x0A	Set Trigger Mode	1.01.0
0x0B	Query number of Plug-in Accessories Present	1.01.0
0x0C	Query Plug-in Identifiers	1.01.0
0x0D	Detect Plug-ins	1.01.0
0x60	General I ² C Read	1.01.0
0x61	General I ² C Write	1.01.0

EP2 Command Byte Value	Description	Version
0x6A	Write Register Information	1.01.0
0x6B	Read Register Information	1.01.0
0x6D	Read Irradiance Calibration Factors	1.01.0
0x6E	Write Irradiance Calibration Factors	1.01.0
0xFE	Query Information	1.01.0

USB Command Descriptions

A detailed description of all Maya commands follows. While all commands are sent to EP1 over the USB port, the byte sequence is command dependent. The general format is the first byte is the command value and the additional bytes are command specific values.

Byte 0	Byte 1	Byte 2	...	Byte n-1
Command Byte	Command Specific	Command Specific	...	Command Specific

Initialize Maya

Initializes certain parameters on the Maya and sets internal variables based on the USB communication speed the device is operating at. This command should be called at the start of every session however if the user does not call it, it will be executed on the first Request Scan command. The default values are set as follows

Parameter	Default Value
Trigger Mode	0 – Normal Trigger

Byte Format

Byte 0
0x01

Set Integration Time

Sets the Maya integration time in milliseconds. The value is a 32-bit value whose acceptable range is 8 – 16,000,000ms (1600s or 26.67min). If the value is outside this range the value is unchanged. For integration times less than 655,000ms, the integration counter has a resolution of 1ms. For integration times greater than this the integration counter has a resolution of 25ms.

Byte Format

Byte 0	Byte 1	Byte 2	Byte 3	Byte 4
0x02	LSW-LSB	LSW-MSB	MSW-LSB	MSW-LSB

MSW & LSW: Most/Least Significant Word

MSB & LSB: Most/Least Significant Byte

Set Strobe Enable Status

Sets the Maya Lamp Enable line (J2 pin 25) as follows. The Single Strobe and Continuous Strobe signals are enabled/disabled by this Lamp Enable Signal.

Data Byte = 0 → Lamp Enable Low/Off
Data Byte = 1 → Lamp Enable HIGH/On

Byte Format

Byte 0	Byte 1	Byte 2
0x03	Data byte LSB	Data Byte MSB

Query Information

Queries any of the 20 stored spectrometer configuration variables. . The Query command is sent to End Point 1 Out and the data is retrieved through End Point 1 In. When using Query Information to read EEPROM slots, data is returned as ASCII text. However, everything after the first byte that is equal to numerical zero will be returned as garbage and should be ignored.

The Query command is sent to End Point 1 Out and the data is retrieved through End Point 1 In. The 20 configuration variables are indexed as follows:

Data Byte - Description
0 – Serial Number
1 – 0 th order Wavelength Calibration Coefficient
2 – 1 st order Wavelength Calibration Coefficient
3 – 2 nd order Wavelength Calibration Coefficient
4 – 3 rd order Wavelength Calibration Coefficient
5 – Stray light constant
6 – 0 th order non-linearity correction coefficient
7 – 1 st order non-linearity correction coefficient
8 – 2 nd order non-linearity correction coefficient
9 – 3 rd order non-linearity correction coefficient
10 – 4 th order non-linearity correction coefficient
11 – 5 th order non-linearity correction coefficient
12 – 6 th order non-linearity correction coefficient
13 – 7 th order non-linearity correction coefficient
14 – Polynomial order of non-linearity calibration
15 – Optical bench configuration info #1: gg fff sss gg – Grating #, fff – filter wavelength, sss – slit size
16 – Maya configuration info #2: Detector Serial Number
17 – Reserved
18 – Power up Baud Rate Value
19 – User Defined

Byte Format

Byte 0	Byte 1
0x05	Data byte

Return Format (EP7)

The data is returned in ASCII format and read in by the host through End Point 7.

Byte 0	Byte 1	Byte 2	Byte 3	...	Byte 17
0x05	Configuration Index	ASCII byte 0	ASCII byte 1	...	ASCII byte 15

Write Information

Writes any of the 19 stored spectrometer configuration variables to EEPROM. The 19 configuration variables are indexed as described in the Query Information. The information to be written is transferred as ASCII information.

Byte Format

Byte 0	Byte 1	Byte 2	Byte 3	...	Byte 17
0x06	Configuration Index	ASCII byte 0	ASCII byte 1	...	ASCII byte 15

Request Spectra

Initiates spectra acquisition. The Maya will acquire a complete spectra (2068 data values). The data is returned in bulk transfer mode through EP2. The table below provides the pixel order for the two different speeds. The pixel values are decoded as described below.

Byte Format

Byte 0
0x09

Return Format

The format for the returned spectral data is dependant upon the USB communication speed. The format for both High Speed (480 Mbps) and Full Speed (12Mbps) is shown below. All pixel values are 16 bit values which are organized in LSB | MSB order. There is an additional packet containing one value that is used as a flag to insure proper synchronization between the PC and Maya.

Note

Maya2000 has 2080 pixels and Maya2000-Pro has 2068. Both read out 4609 bytes, some of which are filler:

- For Maya2000, bytes 0-4159 correspond to pixels 0-2079, bytes 4160—4607 are filler, and byte 4608 is a sync byte
 - For Maya200-Pro, bytes 0-4135 correspond to pixels 0-2067, bytes 4136-4607 are filler, and byte 4608 is a sync byte
-

USB High Speed (480Mbps) Packet Format

In this mode, all data is read from EP2In. The packet format is described below.

Packet #	End Point	# Bytes	Pixels
0	EP2In	512	0-255
1	EP2In	512	256-511
2	EP2In	512	512-767
3	EP2In	512	768-1023
4	EP2In	512	1024-1279
5	EP2In	512	1280- 1535
6	EP2In	512	1536-1791
7	EP2in	512	1792-2047
8	EP2In	512	2048-2303

Packet #	End Point	# Bytes	Pixels
9	EP2In	1	Sync Packet

The format for the first packet is as follows (all other packets except the synch packet has a similar format except the pixel numbers are incremented by 256 pixels for each packet).

Packet 0

Byte 0	Byte 1	Byte 2	Byte 3
Pixel 0 LSB	Pixel 0 MSB	Pixel 1 LSB	Pixel 2 MSB
...			
		Byte 510	Byte 511
		Pixel 255 LSB	Pixel 255 MSB

Packet 18 – Synchronization Packet (1 byte)

Byte 0
0x69

USB Full Speed (12Mbps) Packet Format

In this mode all data is read from EP2In. The pixel and packet format is shown below.

Packet #	End Point	# Bytes	Pixels
0	EP2In	64	0-31
1	EP2In	64	32-63
2	EP2In	64	64-95
...	EP2In	64	
65	EP2In	64	2080-2111
66	EP2In	1	Sync Packet

Packet 0

Byte 0	Byte 1	Byte 2	Byte 3
Pixel 0 LSB	Pixel 0 MSB	Pixel 1 LSB	Pixel 2 MSB
...			
		Byte 62	Byte 63
		Pixel 31 LSB	Pixel 31 MSB

Packet 123 – Synchronization Packet (1 byte)

Byte 0
0x69

Set Trigger Mode

Sets the Maya Trigger mode to one of three states. If an unacceptable value is passed then the trigger state is unchanged (Refer to the [External Triggering Options Instructions](#) for a description of the trigger modes).

Data Value = 0 → Normal (Free running) Mode
Data Value = 1 → Software Trigger Mode
Data Value = 2 → Not Supported
Data Value = 3 → Quasi Real-time Acquisition Mode

Byte Format

Byte 0	Byte 1	Byte 2
0x0A	Data Value LSB	Data Value MSB

General I²C Read

Performs a general purpose read on the I²C pins for interfacing to attached peripherals. The time to complete the command is determined by the amount of data transferred and the response time of the peripheral. The I²C bus runs at 400KHz. The maximum number of bytes that can be read is 61.

Command Byte Format

Byte 0	Byte 1	Byte 2
0x60	I ² C Address	Bytes to Read

Return Byte Format

Byte 0	Byte 1	Byte 2	Byte 3	...	Byte N+3
I ² C Results	I ² C Address	Bytes to Read	Data Byte 0	...	Data byte N
I ² C Result Value	Description				
0	I ² C bus Idle				
1	I ² C bus Sending Data				
2	I ² C bus Receiving Data				
3	I ² C bus Receiving first byte of string				
5	I ² C bus in waiting for STOP condition				
6	I ² C experienced Bit Error				
7	I ² C experience a Not Acknowledge (NAK) Condition				
8	I ² C experienced successful transfer				
9	I ² C bus timed out				

General I²C Write

Performs a general purpose write on the I²C pins for interfacing to attached peripherals. The time to complete the command is determined by the amount of data transferred and the response time of the peripheral. The I²C bus runs at 400KHz. The results codes are described above.

Command Byte Format

Byte 0	Byte 1	Byte 2	Byte 3	...	Byte N+3
0x61	I ² C Address	Bytes to Write	Data Byte 0	...	Data byte N

Return Byte Format

Byte 0
I ² C Results

Write Register Information

Most all of the controllable parameters for the Maya are accessible through this command (e.g., GPIO, strobe parameters, etc). A complete list of these parameters with the associate register information is shown in the table below. Commands are written to End Point 1 Out typically with 4 bytes (some commands may require more data bytes). All data values are 16 bit values transferred in MSB | LSB order. This command requires 100us to complete; the calling program needs to delay for this length of time before issuing another command. In some instances, other commands will also write to these registers (i.e., integration time), in these cases the user has the options of setting the parameters through 2 different methods.

Byte Format

Byte 0	Byte 1	Byte 2	Byte 3
0x6A	Register Value	Data Byte LSB	Data Byte MSB

Register Address	Description	Default Value	Min Value	Max Value	Time Base
0x00*	Master Clock Counter Divisor	6	1	0xFFFF	48MHz
0x04	FPGA Firmware Version (Read Only)				
0x08	Continuous Strobe Timer Interval Divisor	48000	0	0xFFFF	Continuous Strobe Base Clock (see Register 0x0C)
0x0C	Continuous Strobe Base Clock Divisor	4800	0	0xFFFF	48MHz

Maya Data Sheet

Register Address	Description	Default Value	Min Value	Max Value	Time Base
0x10*	Integration Period Base Clock Divisor	1000	0	0xFFFF	1MHz
0x14	Set base_clk or base_clkx2 0: base_clk 1: base_clkx2	1	0	1	N/A
0x18*	Integration Clock Timer Divisor	10	0	0xFFFF	Integration Period Base Clock (see Register 0x10)
0x20*	Reserved				
0x28	Reserved				
0x2C&*	Reserved				
0x30	Reserved				
0x38	Single Strobe High Clock Transition Delay Count	1	0	0xFFFF	1MHz
0x3C	Single Strobe Low Clock Transition Delay Count	5	0	0xFFFF	1MHz
0x40	Lamp Enable	0	0	1	N/A
0x48	GPIO Mux Register 0: pin is GPIO pin 1: pin is alternate function	0	0	0x03FF	N/A
0x50	GPIO Output Enable 1: pin is output 0: pin is input	0	0	0x03FF	N/A
0x54	GPIO Data Register For Output: Write value of signal For Input: Read current GPIO state	0	0	0x03FF	N/A
0x58	Reserved				
0x60	Bit*(0) => Reserved	1	0	1	N/A
	Bit*(1) => Reserved DO NOT MODIFY	0	0	1	N/A
	Bit*(2) => Reserved DO NOT MODIFY	1	0	1	N/A

Register Address	Description	Default Value	Min Value	Max Value	Time Base
	Bit*(3) => Reserved DO NOT MODIFY	0	0	1	N/A
	Bit*(4) => Reserved DO NOT MODIFY	0	0	1	N/A

Notes: * - User should not change these values because spectrometer performance can be effected. This information is included just for completeness
& - These values are controlled by other command interfaces to the Maya (i.e Set integration time command).

Read Register Information

Reads the values from any of the registers above. This command is sent to End Point 1 Out and the data is retrieved through End Point 1 In.

Byte Format

Byte 0	Byte 1
0x6B	Register Value

Return Format (EP1In)

Byte 0	Byte 1	Byte 2
Register Value	Value MSB	Value LSB

Read Irradiance Factors

Reads 60 bytes of data, which is utilized for Irradiance Calibration information from the desired EEPROM memory address.

Byte Format

Byte 0	Byte 1	Byte 2
0x6D	EEPROM Address LSB	EEPROM Address MSB

Return Byte Format

Byte 0	Byte 1	...	Byte 59
Byte 0	Byte 1	...	Byte 59

Write Irradiance Factors

Write 60 bytes of data, which is utilized for Irradiance Calibration information to the desired EEPROM memory address.

Byte Format

Byte 0	Byte 1	Byte 2	Byte 3	...	Byte 62
0x6E	EEPROM Address LSB	EEPROM Address MSB	Byte 0	...	Byte 59

Query Status

Returns a packet of information, which contains the current operating information. The structure of the status packet is given below.

Byte Format

Byte 0
0xFE

Return Format

The data is returned in Binary format and read in by the host through End Point 1 In. The structure for the return information is as follows

Byte	Description	Comments
0-1	Number of Spectral Data Values – WORD(s)	LSB MSB order
2-5	Integration Time - WORD	Integration time in μ s – LSW MSW. Within each word order is LSB MSB
6	Lamp Enable	0 – Signal LOW 1 – Signal HIGH
7	Trigger Mode Value	
8	Spectral Acquisition Status	For internal use
9	Packets In Spectra	Returns the number of Packets in a Request Spectra Command.
10	Power Down Flag	0 – Circuit is powered down 1 – Circuit is powered up
11	Packet Count	Number of packets that have been loaded into End Point Memory
12	Reserved	
13	Reserved	
14	USB Communications Speed	0 – Full Speed (12Mbps) 0x80 – High Speed (480 Mbps)
15	Reserved	